

NEW ISUZU D-MAX X-TERRAIN

BREAKING BOUNDARIES

NEW ISUZU D-MAX X-TERRAIN

BREAKING BOUNDARIES



Authorised Dealer

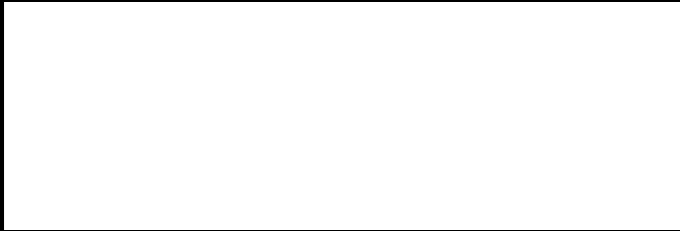

Isuzu Malaysia Sdn. Bhd. 200401026438 (664946-H)
501D, Level 5, Tower D, Uptown 5, No. 5, Jalan SS21/39,
Damansara Uptown, 47400 Petaling Jaya, Selangor.

Visuals and specifications shown in this brochure may differ from actual model.
Isuzu Malaysia Sdn. Bhd. reserves the right to change technical specifications and
features without prior notice. All optional accessories are subject to additional charges.



L I V E L I M I T L E S S

ISUZU

WORLD-RENOWNED PICK-UP TRUCKS MANUFACTURER

After nearly a century of building more than 26 million engines globally, Isuzu has now established a reputation as a strong and reliable pick-up truck manufacturer. Our core philosophy has always been upholding the Isuzu "Truck DNA", which is producing pick-ups engineered for durability, reliability, and fuel efficiency.



Over 85 Years
Pick Up Professional &
Diesel Engine Supremacy

L I V E L I M I T L E S S



The New Isuzu D-Max X-Terrain is engineered to go further than ever, with every detail of its design, technology, performance, and safety features carefully designed.

It doesn't end there - The New Isuzu D-Max X-Terrain is constructed with durability in mind, providing owners with more assurance and peace of mind with its **7 YEARS UNLIMITED MILEAGE WARRANTY**.

The New Isuzu D-Max X-Terrain not only challenges the boundaries of what a pick-up truck can do, but also allows the driver to live the way they truly want to - without limits.





BEST OF ALL WORLDS

Once inside The New Isuzu D-Max X-Terrain, endless possibilities await. Equipped with powerful performance, the ability to go on off-road journeys, and smart driving features - each adventure is better than the last.

THE APPEARANCE THAT DEFINES YOU

With a bold, sharp look, and brilliant functionality - the result is a design that speaks for you.

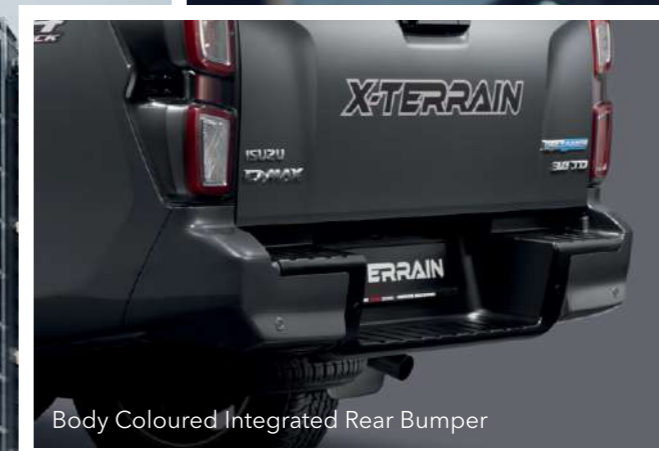

Body Coloured Integrated Rear Bumper



Follow-Me-Home Light



New 18 inch Alloy Wheels



Automatic Bi-LED Projector Headlamps with LED DRL



LED Rear Combi Lamps



SMART. SHARP. STYLISH.

Not only does it look smart, but it's also street smart. Enjoy practical features that enhance every journey.



Sliding Cargo Tray (Optional Accessory)



Sports Bar (Optional Accessory)



Roof Rails



Automatic Aerofoil Wet Wiper System



Tailgate Assist



Auto Fold Side Mirrors



9 inch Touch Screen Infotainment System with Apple CarPlay and Android Auto Connectivity
Subject to smartphone compatibility

COMFORT THAT KNOWS NO COMPROMISE

Step into a world of comfort in the new cabin. The New Isuzu D-Max X-Terrain comes with beautiful new dark leather seats and touches of refinement such as Illuminated Scuff Plate, new Ambient Lighting, and many more.



Rear Vents with USB Charging Port



Automatic Dual Zone Climate Control



New Black Combination Leather Seats with Anti Vibration Elastic Comfort Foam



Illuminated Scuff Plate



8-Way Power Adjust with Lumbar Support



CONVENIENCE COMES EASY

Experience state-of-the-art technology made for your convenience. Everything you need in The New Isuzu D-Max X-Terrain is at the palm of your hand.



Passive Entry & Start System with Remote Engine Start



8-Speaker Live Surround Sound



Auto Dimming Rear View Mirror



Wireless Charger with New Type-C USB Charging Port



e-LUMAX with Colour Display MID



Multi-Function Leather Wrapped Steering Wheel with Tilt & Telescopic Adjustment

360° Around View Monitor

THE POWER YOU DESERVE

Designed to take you on any adventure, anywhere, anytime.

The 3.0 litre Blue Power Turbo Diesel engine packing **190PS and 450Nm** of torque is set to fulfil everything your adventurous spirit asks for.

6-Speed Automatic Transmission with Sequential Shift



3.0TD
BLUE POWER

Charge ahead
190PS
450Nm



TAKE CHARGE ANYWHERE

Venture effortlessly into any terrain with state-of-the-art features. The New Isuzu D-Max X-Terrain is engineered to take you on the best adventures of your life.



The chassis of The New Isuzu D-Max X-Terrain has been improved in many innovative ways. It is bigger, higher, wider, and has more cross members for stability and safety.

Before being given the all-clear to hit the road, The New Isuzu D-Max X-Terrain underwent a rigorous 4 million-kilometre durability test to ensure quality of the vehicle.



TERRAIN COMMAND

Switch between 2WD, 4WD-high, and 4WD-low modes in less than a second with Terrain Command. Manoeuvre effortlessly on normal pavements, wet roads, and off-road conditions.

800mm Water Wading Depth
Wading depth of 800mm allows you to navigate water crossings with confidence.



4x4 DIFF-LOCK

Rear Differential Lock
The differential lock makes sure you have the traction you need to get out of difficult obstacles when travelling off-road.



Under-Body Protection
Go on all sorts of adventures without worries with the essential parts of your New Isuzu D-Max X-Terrain protected by steel under-body guard.



FIRM FOR ANY ADVENTURE

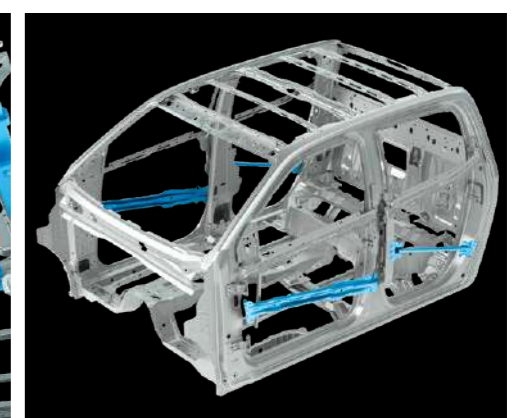
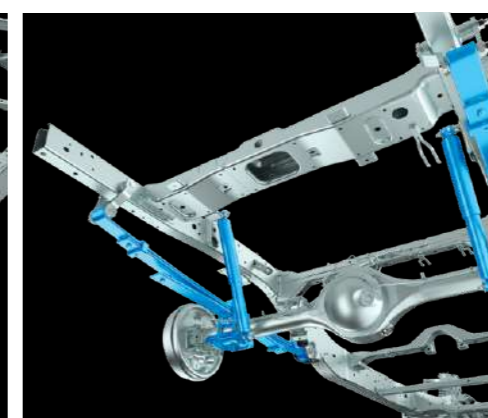



01 & 02



06



03



07

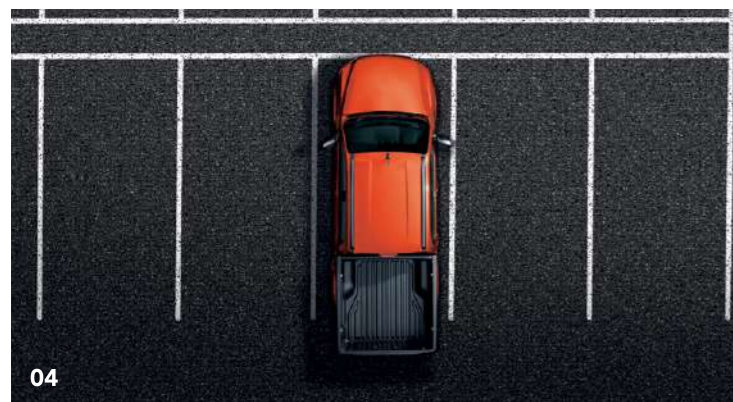

04

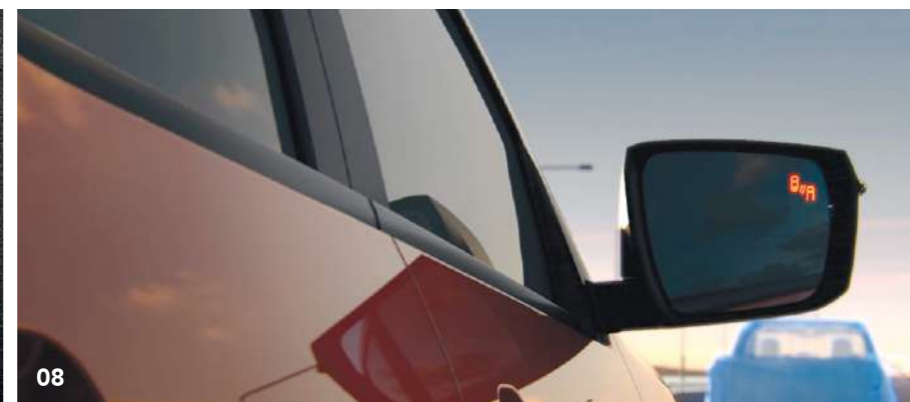

08



05



09

Complete safety features with
ADAS
 ADVANCED DRIVER ASSIST SYSTEM

01 Forward Collision Warning (FCW)
 Alerts the driver when a potential collision is detected in front of the vehicle.

02 Autonomous Emergency Braking (AEB)
 Brakes automatically when a potential collision is detected.

03 Turn Assist
 Monitors opposing traffic when the vehicle is about to turn and brakes automatically to avoid accidents.

04 AT Pedal Misapplication Mitigation
 Detects whether the accelerator has been applied accidentally and automatically suppresses the engine power and alerts the driver if there is a vehicle in front.

05 Adaptive Cruise Control with Stop and Go (ACC)
 Adjusts cruising speed based on vehicles in front of you, while also including Stop & Go functionality.

06 Lane Departure Warning (LDW)
 The vehicle detects and warns the driver should you drift towards another lane.

07 Automatic High Beam (AHB)
 The D-Max dims the high beam automatically at night to avoid dazzling other drivers.

08 Blind Spot Monitor (BSM)
 Detects when a vehicle is approaching your blind spot and warns you through your side mirrors.

09 Rear Cross Traffic Alert (RCTA)
 Detects when an object approaches the rear of the vehicle and alerts the driver.

Manual Speed Limiter (MSL)
 Allows a maximum speed to be set so that the driving speed could not exceed the set speed limit.

Multi Collision Brake
 The D-Max's multi-collision brake systems can prevent or mitigate subsequent impact in the event of an accident.

ALLSIGHT
 Isuzu Comprehensive Safety Technology

SAFETY AT ITS FINEST

Isuzu ALLSIGHT is an all-inclusive safety package available in the flagship X-Terrain model; which consists of an Advanced Driver Assist System, Active Safety Systems, and Passive Safety Systems, that employs advanced sensors, a stereo camera, and cutting-edge technology to mitigate road hazards and provide peace of mind while driving.



SUPREME STANDARDS OF SAFETY



ALLSIGHT Isuzu Comprehensive Safety Technology

01 7-SRS Airbags

For the ultimate protection, The New Isuzu D-Max X-Terrain comes with 7 SRS airbags to ensure the driver and every passenger are in safe hands.

02 Anti-lock Brake System (ABS)

In emergency situations, the system ensures the vehicle can still be manoeuvred.

03 Electronic Brake-force Distribution (EBD)

Allows the control of braking force between the front and rear wheels depending on vehicle load.

04 Brake Assist (BA)

In emergency situations, the system helps to apply full braking force.

05 Electronic Stability Control (ESC)

Helps you stay in control of the vehicle.

06 Traction Control System (TCS)

Allows for greater control over the road or terrain.

07 Hill Start Assist (HSA)

Prevents vehicle roll-back automatically when starting on steep gradients.

08 Welcome Light

An automatic welcome light at the side steps provides illumination using sensors that detects your approach to the vehicle within 2 metres with the key.

09 Walk Away Door Lock

Allows the vehicle to lock automatically after you walk 3 metres away from it with the key in your hands.

10 Front & Rear Digital Video Recorder (DVR)

Every journey you go on is recorded for your peace of mind.

Hill Descent Control (HDC)

Automatically controls the brakes and maintains vehicle speed while descending steep slopes.

Emergency Stop Signal (ESS)

In emergency situations, warning lights are activated to indicate that the vehicle is braking rapidly.

Front & Rear Parking Sensor

8 sensors provide instantaneous feedback to detect objects during parking.

Reverse Camera

While you reverse, the system monitors the surrounding area behind the vehicle.

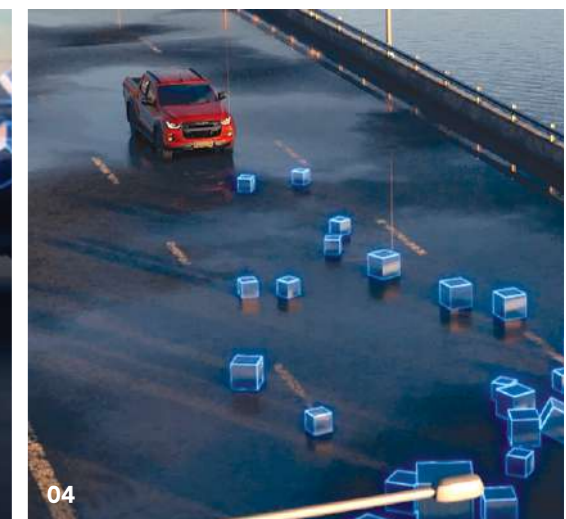

X-TERRAIN V-CROSS 3.0L 4X4 AT

ENGINE

Model	4JJ3-TCX
Type	In-Line 4-Cylinder VGS Turbo Intercooler Diesel DOHC 16V
Displacement (cc)	2,999
Bore x Stroke (mm)	95.4 x 104.9
Compression Ratio	16.3 : 1
Maximum Output (PS / rpm) [ISO NET]	190 / 3,600
Maximum Torque (Nm / rpm) [ISO NET]	450 / 1,600 - 2,600
Fuel System	Direct Injection Electronic Commonrail

TRANSMISSION

Type	6-Speed Automatic with Sequential Shift
------	---

CHASSIS & SUSPENSION

Suspension	Front	Independent Double Wishbones, Coil Springs & Stabilizers with Gas Shock Absorbers
	Rear	Semi-Elliptical Leaf Springs with Gas Shock Absorbers
Brakes	Front	Ventilated Disc
	Rear	Leading & Trailing Drums
Terrain Command 4X4 System		Equipped
Rear Differential Lock		Equipped
Steering System		Rack & Pinion Hydraulic Power Steering
Min. Turning Radius (m)		6.25
Tyres & Wheels		265/60R18 All-Terrain, 18 inch Dark Grey Alloy
Spare Tyre & Wheel		265/60R18, Steel

DIMENSION, WEIGHT & CAPACITIES

Overall Length (mm)	5,270
Overall Width (mm)	1,870
Overall Height (mm)	1,810
Wheelbase (mm)	3,125
Deck Length (mm)	1,571
Deck Width (mm)	1,530
Deck Height (mm)	490
Min. Ground Clearance (mm)	240
Water Wading Depth (mm)	800
Kerb Weight (kg)	2,025
Gross Weight (kg)	2,600
Seating Capacity	5
Fuel Tank Capacity (L)	76

EXTERIOR

Headlamps	Automatic Bi-LED Projector with Follow-Me-Home Light
Daytime Running Lights (DRL)	LED
Headlamp Levelling	Automatic
Fog Lamps	Equipped - Front & Rear LED
Front Grille	Dark Grey & Black Chrome
Front Bumper Lower	Equipped
Windscreen & Door Glass	With Infra-Red Cut
Wipers	Automatic Aerofoil Wet Wiper with Variable Intermittent
Roof Rails	Equipped - Dark Grey
Door Outer Mirrors	Dark Grey - Power Adjust, Auto Folding with LED Integrated Turn Indicator
Door & Tailgate Handles	Dark Grey
Over Fenders	Equipped - Dark Grey
Side Steps	Equipped - Dark Grey
Welcome Light	Equipped
Bed Liner	Equipped
Tailgate Assist	Equipped
Sports Bar	Optional
Cargo Tray	Optional
Rear Combination Lamps	LED
Rear Bumper	Body Coloured Integrated Two Step Type

INTERIOR

Meter Panel	e-LUMAX with Satin Chrome Ornament & Illumination Control	
Multi Information Display (MID)	4.2 inch TFT LCD Colour Display	
Steering Wheel	Type	4-Spoke Leather Wrapped with Brown Stitch
	Adjustment	Tilt & Telescopic
	Switches	Audio, Bluetooth Hands-Free, Voice Recognition, MID, Manual Speed Limiter & Adaptive Cruise Control
Lane Changing Mode	Equipped	
Cruise Control	Adaptive	
Passive Entry & Start System (PESS)	Equipped	
Remote Engine Start	Equipped	
Welcome Light	Equipped	
Walk Away Door Lock	Equipped	
Sun Visor	Equipped with Vanity Mirror & Light for Driver & Front Passenger	

INTERIOR

Map Lamp	Dual for Driver & Front Passenger with Sunglass Holder	
Rear View Mirror	Auto Dimming	
Audio System	Type	9 inch Touch Screen Infotainment with USB, Bluetooth, WiFi, MirrorLink, Miracast, Apple CarPlay & Android Auto Connectivity
	Speaker	8 (with Roof Speakers)
Climate Control	Type	Automatic Dual Zone
	Rear Vents	Equipped
USB Ports	Front	Equipped (1 USB Type-C & 1 USB Type-A)
	Rear	Equipped with Storage (1 USB Type-A)
Digital Video Recorder (DVR)		Equipped - Front & Rear
Wireless Charger		Equipped
Gear Knob Type		Leather with Satin Chrome Ornament & Brown Stitch
Interior Trim Colour		Black
Instrument, Center Console & Door Panel Soft Pad		Black with Brown Stitch
Seats	Material	Black Combination Leather
	Driver	8-way Power Adjust with Lumbar Support
	Front Passenger	4-way Manual Adjust
	Rear	60:40 Split, Fold Up/Down Configuration with Center Arm Rest & Cup Holder
Power Door Lock		Equipped with Speed Sensing Auto Door Lock & Auto Unlock if Airbag Activated
Power Windows		Equipped with Auto Up/Down & Jam Protection for Driver
Cabin Lamp		Equipped
12V/120W Power Outlet		Equipped
Assist Handles		Fixed Type at A-Pillar & B-Pillar
Carpet Mat		Equipped
Scuff Plate		Equipped with LED Illumination
Ambient Light		Equipped with Blue LED Light

ADVANCED SAFETY (ADAS)

Forward Collision Warning (FCW)	Equipped
Autonomous Emergency Braking (AEB)	Equipped
Turn Assist	Equipped
AT Pedal Misapplication Mitigation	Equipped
Adaptive Cruise Control (ACC)	Equipped with Stop & Go Function
Manual Speed Limiter (MSL)	Equipped
Automatic High Beam (AHB)	Equipped
Lane Departure Warning (LDW)	Equipped
Blind Spot Monitor (BSM)	Equipped
Rear Cross Traffic Alert (RCTA)	Equipped
Multi Collision Brake	Equipped

ACTIVE SAFETY

Anti-lock Brake System (ABS)	Equipped	
Electronic Brake-force Distribution (EBD)	Equipped	
Brake Assist (BA)	Equipped	
Electronic Stability Control (ESC)	Equipped	
Traction Control System (TCS)	Equipped	
Hill Start Assist (HSA)	Equipped	
Hill Descent Control (HDC)	Equipped	
Brake Override System (BOS)	Equipped	
Emergency Stop Signal (ESS)	Equipped	
ISOFIX with Top Tether	Equipped - Rear Seats	
Child Protection Safety Lock	Equipped - Rear Doors	
High Mount Stop Lamp	Equipped	
Around View Monitor (AVM)	Equipped with 3D Image Guide	
Reverse Camera	Equipped	
Parking Sensor	Front	Equipped - 4 Sensors Type
	Rear	Equipped - 4 Sensors Type

PASSIVE SAFETY

SRS Airbags	7 (Driver, Front Passenger, Side, Curtain & Driver Knee)	
Side Door Impact Beams	All Doors	
Collapsible Steering Column	Equipped	
Whiplash Protection	All Seats	
Seat Belts	Front Seat	3-Point ELR with Pre-Tensioner & Load Limiter
	Rear Seat	3-Point ELR
Seat Belt Reminder	All Seats	

SECURITY

Vehicle Security System	Anti-Theft Alarm System with Key-Coded Immobilizer
-------------------------	--

COLOUR VARIANTS



BREAKING BOUNDARIES



The New Isuzu D-Max X-Terrain stands tall as the pick-up truck that challenges all boundaries, made to complement the best version of you as well as everything you can do and become - turning every drive into endless adventures.

Never again live life as you know it. Live limitless with The New Isuzu D-Max X-Terrain.